

Disclaimer and Warning

Congratulations on purchasing your new DJI product. The information in this document affects your safety and your legal rights and responsibilities. Read this entire document carefully to ensure proper configuration before use. Failure to read and follow instructions and warnings in this document may result in serious injury to yourself or others, or damage to your DJI product or damage to other objects in the vicinity. This document and all other collateral documents are subject to change at the sole discretion of DJI. For up-to-date product information, visit <http://www.dji.com> and click on the product page for this product.

By using this product, you hereby signify that you have read this disclaimer and warning carefully and that you understand and agree to abide by the terms and conditions herein. You agree that you are solely responsible for your own conduct while using this product, and for any consequences thereof. You agree to use this product only for purposes that are proper and in accordance with all applicable laws, rules, and regulations, and all terms, precautions, practices, policies and guidelines DJI has made and may make available.

DJI accepts no liability for damage, injury or any legal responsibility incurred directly or indirectly from the use of this product. The user shall observe safe and lawful practices including, but not limited to, those set forth in this document.

Glossary

Warning: Failure to properly follow procedures may result in property damage, collateral damage, and serious or superficial injury.

Before You Begin

The following documents have been produced to help you safely operate and make full use of your DJI Focus:

DJI Focus Remote Controller Quick Start Guide

DJI Focus Remote Controller User Manual

Check all of the included parts listed in the In the Box section below. Read the entire User Manual and watch the informational on the product page of DJI's official website (<http://www.dji.com/remotecontroller/focus>). Read the disclaimers and warnings above to understand your legal rights and responsibilities. If you have any questions or problems during the installation, maintenance or use of this product, please contact DJI or a DJI authorized dealer.

⚠ WARNING

1. Only use official DJI batteries that can be purchased on www.dji.com. DJI takes no responsibility for any damage to your devices caused by non-DJI batteries.
2. Never use swollen, leaky, or damaged batteries. If your batteries show any abnormal signs in performance, contact DJI or a DJI authorized dealer for assistance.
3. Never disassemble or pierce the battery in any way, or else the battery may leak, catch fire, or explode.
4. DO NOT attach the batteries to wall outlets or car charger sockets directly, and always use a DJI approved adapter. DJI takes no responsibility if the battery is charged using a third party charger.

DJI FOCUS REMOTE CONTROLLER

Quick Start Guide

V1.0

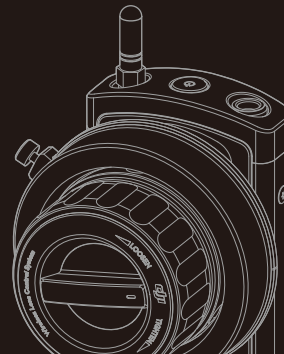

In the Box

Check that all of the following items are included in the package. If any items are missing, contact DJI Support or your local DJI authorized dealer.

Remote Controller x1

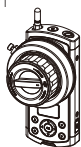

Customizable CAN Bus Cable x1



Marking Ring x3



Neck Strap x1



Micro USB Cable x1



Hook-and-loop Strap x1



Manuals

DJI Focus Remote Controller Quick Start Guide

DJI FOCUS REMOTE CONTROLLER

www.dji.com

Remote Controller Diagram

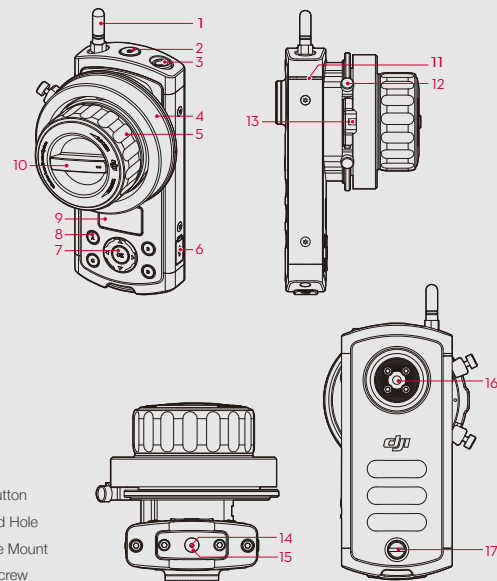

1

Attaching the Neck Strap

Insert the neck strap connector while pulling on the button.

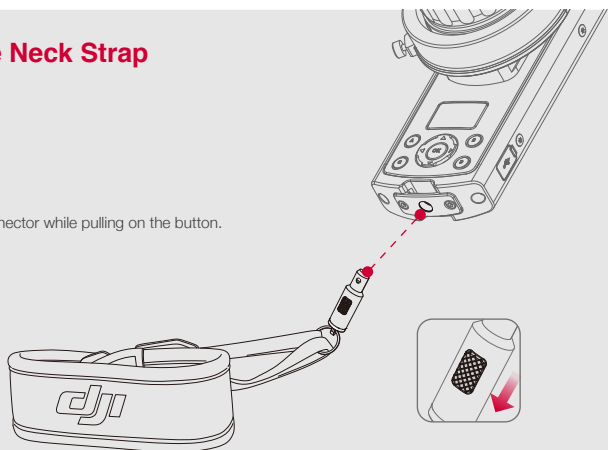

 - Ensure the neck strap is attached securely.

2

Using with the Zenmuse X5

To allow the Focus Remote Controller to control the focus and aperture of the Zenmuse X5, connect the communication port on the Focus Remote Controller to the CAN Bus port on the Inspire 1 remote controller using the dedicated CAN Bus cable.

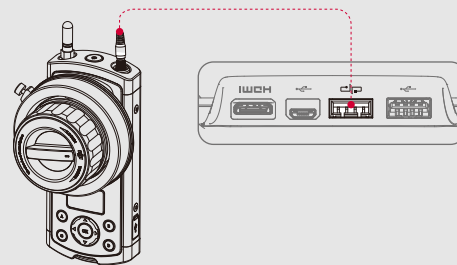

 - Ensure that the Zenmuse X5 camera is set in AF mode.
 - In the DJI GO app, ensure that the shooting mode is set to 'M' (Manual mode) or 'A' (Aperture priority).

3

Settings

Turn on the remote controller by holding down the power button for 2 seconds.

The Focus Remote Controller controls the focus of the Zenmuse X5 by default. To enable aperture control, select 'Menu (right key) > Aperture > On'.

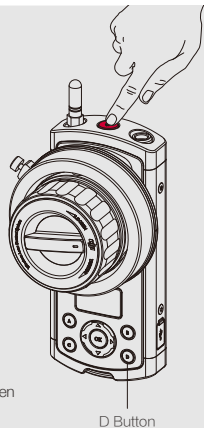
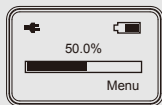

Once aperture control is enabled, the 'D' button is used to switch between focus control and aperture control. To switch from focus control to aperture control, press the 'D' button and then follow the instructions in the DJI GO app to operate the focus wheel.

 - The remote controller overrides the in-app controls. You will not be able to adjust the focus or aperture in the DJI GO app.

4

Basic Operation

Turn the focus wheel to control focus or aperture of the lens.

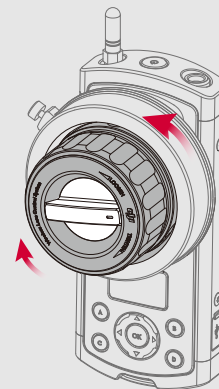

* For more information, read the user manual:
<http://www.dji.com/product/focus/download>